

Aesculap® Neurosurgery

Yasargil® Permanent Aneurysm Clips

USA

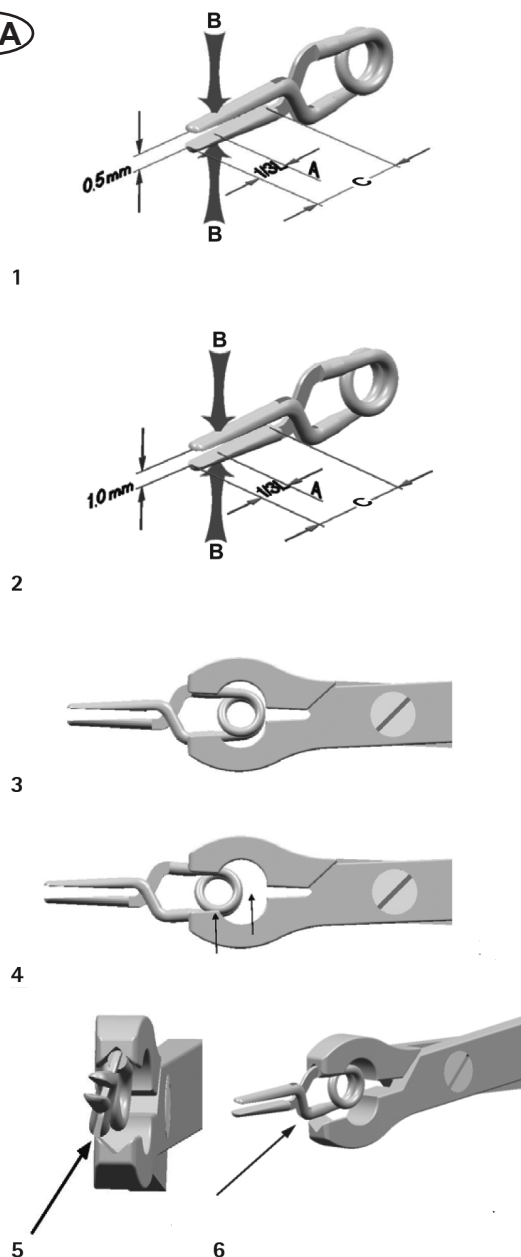

YASARGIL ANEURYSM CLIPS

Figure captions:

- 1 Yasargil Phynox® aneurysm clip, example of a straight clip
- 2 Yasargil titanium aneurysm clip, example of a straight clip
- 3 Yasargil aneurysm clip, correctly positioned
- 4 Yasargil aneurysm clip, incorrectly positioned
- 5 Yasargil aneurysm clip, incorrectly positioned
- 6 Yasargil aneurysm clip, incorrectly positioned

LEGEND

- A Test point
- B Force
- C Length of jaw part

INDICATIONS FOR USE

The Yasargil Aesculap Aneurysm Clips are intended for occlusion of cerebral aneurysms in a permanent manner. They are applied with Aesculap clip applicators, which contain titanium alloy or Phynox jaws.

“Aesculap Yasargil aneurysm clips” will be referred to as “aneurysm clips” in the following text.

PERMANENT ANEURYSM CLIPS

The permanent aneurysm clips are intended for permanent stasis of cerebral aneurysms.

The permanent aneurysm clips are intended for single use only.

CONTRAINDICATION

The permanent aneurysm clips are contraindicated for all applications except for the permanent stasis of cerebral aneurysms.

WARNINGS

Each aneurysm clip is individually packaged and provided sterile and is intended for use on a single patient during a single procedure. Aesculap recommends sterile presentation to the operative field to ensure the integrity

STERILE R



Sterilized using irradiation.

Single use

Use-by Date

Caution

Pictorial is for reference only

SOP-AIC-5000566 Ver. 04 03/24

and performance of the clip and to ensure accurate retention of implant information on intraoperative records. Permanent aneurysm clips are indicated for permanent occlusion of aneurysms and, therefore, repeated or multiple application during the procedure should be avoided. Any aneurysm clip that has come in contact with a patient's blood or bodily fluid should not, under any circumstances, be cleaned, re-sterilized or in any other way prepared for use in another patient.

PRODUCT DESCRIPTION

The aneurysm clips are available in two different materials:

- Cobalt alloy (Phynox®) ISO 5832-7 and
- Titanium alloy Ti6Al4V, ISO 5832-3.

Different models of aneurysm clips are available. Please contact your local Aesculap® sales representative for more information or consult the Yasargil® Aneurysm brochure located at www.aesculapusa.com. The aneurysm clips are available in three sizes (Mini, Standard and Long).

The closing force of each aneurysm clip is measured individually and printed on the individual packaging. The closing force given on the packaging was measured at 1/3 along the length (from the tip) of the jaw part, at the center of the contact area. The Phynox aneurysm clips are measured with the jaws opened to 0.5 mm (see Fig. 1) whereas the titanium aneurysm clips are measured with the jaws opened to 1 mm (see Fig. 2).

Each aneurysm clip carries an individual serial number. The aneurysm clips are color-coded to differentiate the various sizes and applications.

Special product description for permanent aneurysm clips:

	Phynox Aneurysm Clips			Titanium Aneurysm Clips	
Size	Mini	Standard	Long	Mini	Standard
Color Coding	Silver			Jaw Part: Silver Spring: Pink	Jaw Part: Silver Spring: Blue

Each permanent aneurysm clips package contains additional labels showing the article number and the individual serial number of the clip.

MRI SAFETY INFORMATION



The Yasargil Titanium Aneurysm Clips are MR Conditional.

Non-clinical testing demonstrated that the Yasargil Titanium Aneurysm Clips are MR Conditional. A patient with this device can be safely scanned immediately after implantation in an MR system meeting the following conditions:

- Static magnetic field of 3-Tesla or less
- Maximum spatial gradient magnetic field of 3,000-Gauss/cm (30.0 T/m) or less
- Maximum MR system reported, whole body averaged specific absorption rate (SAR) of 4-W/kg (First Level Controlled Operating Mode)
- Do not take the aneurysm clip applicator into the MR environment. It is MR Unsafe.

Under the scan conditions defined above, the Yasargil Titanium Aneurysm Clip is expected to produce a maximum temperature rise of +1.8°C after 15 minutes of continuous scanning. In non-clinical testing, the image artifact caused by the device extends approximately 5 mm from the Yasargil Titanium Aneurysm Clip when imaged with a gradient echo pulse sequence and a 3-Tesla MR system.

MRI SAFETY INFORMATION



The Yasargil Phynox Aneurysm Clips are MR Conditional.

Non-clinical testing demonstrated that the Yasargil Phynox Aneurysm Clips are MR Conditional. A patient with this device can be safely scanned immediately after implantation in an MR system meeting the following conditions:

- Static magnetic field of 3-Tesla or less
- Maximum spatial gradient magnetic field of 1,500-Gauss/cm (15.0 T/m) or less
- Maximum MR system reported, whole body averaged specific absorption rate (SAR) of 4-W/kg (First Level Controlled Operating Mode)
- Do not take the aneurysm clip applicator into the MR environment. It is MR Unsafe.

Under the scan conditions defined above, the Yasargil Phynox Aneurysm Clip is expected to produce a maximum temperature rise of +2.2°C after 15 minutes of continuous scanning. In non-clinical testing, the image artifact caused by the device extends approximately 20 mm from the Yasargil Phynox Aneurysm Clip when imaged with a gradient echo pulse sequence and a 3-Tesla MR system.

SAFE HANDLING AND PREPARATION

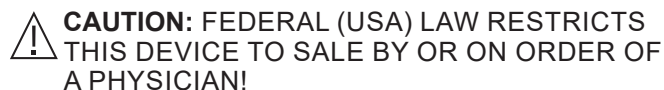

- Read and observe the instructions for use, and keep them in a safe place.
- The product may only be used for its intended application, see Indications for Use.
- Prior to each use, inspect the product for: loose, bent, broken, cracked, worn, or fractured components.
- Do not use the product if it is damaged or defective. Products found to be damaged must be set aside immediately.

Each aneurysm clip is individually packaged and sterilized by radiation (min. dose 25 kGy). If the sterile wrapping is open, torn, perforated or otherwise damaged, or when the sterility of the aneurysm clip has “expired” (use-by date), the aneurysm clip must be regarded as unsterile and has to be sterilized according to the instructions given in the sections on cleaning and sterilizing. Each individually packaged aneurysm clip is supplied in double sterile packaging including instructions for use and labels.

SPECIAL HANDLING AND PREPARATION FOR PERMANENT ANEURYSM CLIPS

Aesculap® recommends keeping the permanent aneurysm clips in the unopened sterile packaging, prior to operation. In this way, damage to the aneurysm clips is avoided, their functionality is ensured and their correct closing force is maintained.

LABELS

Each permanent aneurysm clip package contains additional labels showing the article number and the individual serial number of the clip. To facilitate the subsequent radiological examination, the patient's file (for the hospital) and the patient ID (for the patient) should be marked with these labels.

PATIENT ID

Important information concerning the aneurysm clip implanted and the operation can be noted down on the patient ID.

To facilitate the postoperative radiological examination, each patient should receive a patient ID.

- Contents of the patient ID
 - Patient data
 - Hospital data
 - Date of operation
 - Name of surgeon
 - Article number and individual serial number of the aneurysm clip implanted

The patient ID can be ordered through your Aesculap sales representative.

Patients should register the conditions under which the implant can be scanned safely with the MedicAlert Foundation (www.medicalert.org) or equivalent organization.

 **CAUTION: TO AVOID DAMAGE, PRODUCT MALFUNCTION OR TO AVOID ANY RISK OF A DECREASE CLOSING FORCE:**

- **Apply each aneurysm clip with the appropriate applier and removal forceps.**
- **Never use the aneurysm clips with applier or removal forceps from other manufacturers.**
- The Phynox® aneurysm clips must be applied with the applier for Phynox aneurysm clips. The titanium aneurysm clips must be applied with the applier and removal forceps for titanium aneurysm clips. Mini, Standard or Long aneurysm clips may be used only with the applier and removal forceps of the appropriate size (Mini, Standard or Long).
- All applier and removal forceps are marked according to size (Mini, Standard or Long) and clip material so that their correct application with clips of the respective size and material is ensured. Additionally, the applier and removal forceps for titanium aneurysm clips can also be color-coded according to clip size.

For further information on the suitable applier and removal forceps, please contact your local Aesculap sales representative or consult the Yasargil® Aneurysm Clip Brochure which can be located at www.aesculapusa.com.

- Carefully pick up the whole aneurysm clip with the jaw piece of the appropriate applier forceps (see Fig. 3). The aneurysm clip can be damaged, jump out or slip if picked up improperly (see Fig. 4/5/6).

 **DANGER! TO AVOID POSSIBLE RISKS TO THE PATIENT:**

- **The permanent aneurysm clips are designed for single use only.**

Aesculap cannot accept any responsibility for aneurysm clips that are handled inappropriately or not according to the present instructions for use.

SAFE HANDLING

Aneurysm clips should only be applied by surgeons appropriately trained for, and experienced in, the use of aneurysm clips.

 **CAUTION: IF AN ANEURYSM CLIP APPEARS CHANGED OR SHOWS SIGNS OF DAMAGE, e.g. INCORRECT JAW POSITION, BENT PARTS OR CHANGED CLOSING FORCE:**

- **Set aside the aneurysm clip.**

To avoid damage to the aneurysm clips:

- Always handle the aneurysm clips with appropriate care.
- Never open an aneurysm clip with your fingers.
- Avoid manual and/or mechanical manipulation of the aneurysm clip.

Excessive, rough or repeated handling, especially opening and closing of aneurysm clips, be it in general use or during cleaning and sterilization, can change the closing force and impair the clinical effectiveness of the aneurysm clips.

- As soon as the sterile aneurysm clip has been brought to the operation field in the usual manner, pick up the aneurysm clip from its double sterile packaging and position it carefully between the jaws of the applier forceps.

The correct positioning of the aneurysm clip between the jaws of the appropriate applier forceps (see Fig. 3) is crucial here. If the aneurysm clip is not placed precisely between the jaw's parts of the appropriate applier forceps (see Fig. 4/5/6), this can lead to damage to the aneurysm clip. It could cause a change in the factory-set closing force or result in the aneurysm clip slipping from the applicator, which could be dangerous during an operation. These directions for use must also be observed when using the removal forceps.

- To preclude the possibility of a galvanic reaction; avoid implanting permanent aneurysm clips made of different materials and/or by different manufacturers in such a way that they touch each other.
- Make absolutely certain that the aneurysm clip sits correctly on the aneurysm neck and close to the blood vessel, during and after implantation.

 **DANGER! THE APPLICATION OF ANEURYSM CLIPS INVOLVES THE FOLLOWING SEVERE RISKS:**

- **Shifting or breakage of the aneurysm clip.**
- **Scissoring of the jaw.**

- Rupture of the aneurysm due to punctual, incomplete contact of the clip jaws on the aneurysm neck.
- For large aneurysms, reduction of the blood vessel cross-section close to the edge of the blood vessel.
- Cerebrovascular spasms and sudden death.
- Infections of the operation wound and general surgical complications are other unwelcome (side) effects.

Each patient must be informed comprehensively about the properties of aneurysm clips, the surgical procedure and the importance of the medical ID cards.

CARE AND HANDLING

Each aneurysm clip in its unopened original packaging has been packed and sterilized individually and is supplied as a sterile product. Sterilization of a clip that has been removed from its sterile package may be accomplished by the following sterilization process outlined in the following section.

 **CAUTION: TO PRECLUDE DAMAGE, INACCURATE FUNCTIONING, AND AN INCORRECT CLOSING FORCE:**

- Use each aneurysm clip with the appropriate applier and removal forceps.
- Never use the aneurysm clips with applier or removal forceps from other manufacturers.

Excessive, rough, or repeated handling, especially opening and closing of aneurysm clips, be it in general use or during cleaning and sterilization, can damage the aneurysm clip, change the closing force and impair the clinical effectiveness of the aneurysm clips.

To avoid damage to the aneurysm clips:

- Always handle the aneurysm clips with appropriate care.
- Never open an aneurysm clip with your fingers.
- Avoid manual and/or mechanical manipulation of the aneurysm clip.

 **WARNING: PERMANENT ANEURYSM CLIPS THAT HAVE BEEN IMPLANTED BEFORE OR BEEN IN CONTACT WITH BLOOD, TISSUE, OR BODY FLUIDS:**

- Must be set aside for disposal.
- Must not be sterilized.

CLEANING AND DISINFECTION

SPECIAL CLEANING INSTRUCTIONS FOR PERMANENT ANEURYSM CLIPS

Sterilization must be preceded by the following procedure:

- Mechanical/Automated pH neutral cleaning

Machine type: single-chamber cleaning device without ultrasound

Phase	Step	T [°C/°F]	t [min]	Water-Quality	Chemical/Remarks
I	Pre-rinse (optional)	< 25/77	≥1.5	U/T-W	-
II	Wash Cycle	<55/131	≥6	U/T-W	Enzymatic Cleaner* - pH ~ 7.5 – 8.5 - 0.1 to 0.4 % working solution
III	Final Rinse	90/194	≥2	C/T-W	-
IV	Dry	≥90/194	≥8	-	According to the program for cleaning and disinfection device

U/T-W: Utility/tap water

C/T-W: Critical/treated water

* Validation testing was performed using Prolystica® 2X Concentrate Enzymatic Cleaner (manufactured by Steris).

Other medical device cleaning agents may provide similar results.

- Check visible surfaces for residues after mechanical/automated cleaning.

INSPECTION

- Inspect each individual aneurysm clip.
- Any aneurysm clip found with one of the following characteristics must be set aside and excluded from further use:
 - Signs of damage
 - Incorrect jaw position
 - Bent components
 - Changed closing force
 - Misalignment
 - Soilage that cannot be removed

The color coding may fade in the course of processing. Aneurysm clips whose color coding cannot be identified unambiguously anymore must be set aside and excluded from further use.

STERILIZATION METHOD AND PARAMETERS

Each aneurysm clip in its unopened original packaging has been packed and sterilized individually and is supplied as a sterile product.

 **CAUTION: AN ANEURYSM CLIP MUST BE REGARDED AS UNSTERILE, e.g. IF THE STERILE PACKAGING IS OPEN, TORN, PERFORATED OR DAMAGED, OR IF THE STERILITY OF THE PRODUCT HAS “EXPIRED” (USE-BY DATE).**

- Sterilization has to be carried out through a validated sterilization process.

- **Using a non-validated sterilization process may result in the aneurysm clip being unsterile.**
- **Sterilize the aneurysm clip in the appropriate storage devices recommended by Aesculap® for Aesculap Yasargil® aneurysm clips. For further information on the appropriate storage devices recommended by Aesculap, please contact Aesculap or consult the special brochures for titanium and Phynox® aneurysm clips. These brochures too can be ordered from your Aesculap sales representative.**
- The aneurysm clips are supplied sterile. Sterilization of a clip that has been removed from its sterile package may be accomplished by the following the sterilization process outlined in this section.
- Any **permanent** aneurysm clip that has come in contact with a patient's blood or bodily fluid should not, under any circumstances, be cleaned, re-sterilized or in any other way prepared for use in another patient.
- The product can be cleaned and sterilized up to 100 times if undamaged and used with proper care, **only** if it has not come into contact with a patient's blood or body fluids. Any additional processing falls under the responsibility of the user.
- Sterilization of the device may be accomplished by steam.
- Aesculap does not recommend the device be sterilized by "Flash" or chemical sterilization.
- Surgical instruments may also be placed within the Aesculap rigid sterilization container (sterile container) for processing under generally accepted hospital in-use conditions.

The recommended sterilization parameters are as follows:

- Aesculap advises against sterilizing the device by flash sterilization or chemical sterilization.
- Sterilization may be accomplished by a standard prevacuum cycle in a steam autoclave.

To achieve a sterility assurance level of 10⁻⁶, Aesculap recommends the following parameters:

Aesculap Orga Tray/Sterile container (perforated bottom) Minimum cycle parameters*			
Sterilization method	Temperature	Time	Min. drying time
Prevacuum	270°F	4 min.	20 min.

* Aesculap has validated the above sterilization cycle and has the data on file. The validation was accomplished in an Aesculap sterile container cleared by FDA for the sterilization and storage of these products. Other sterilization cycles may also be suitable, however individuals or hospitals not using the recommended method are advised to validate any alternative method using appropriate laboratory techniques. Use an FDA cleared accessory to maintain sterility after processing, such as a wrap, pouch, etc.

STORAGE

Store the aneurysm clips:

- In their sterile packaging or
- In a compatible storage system recommended by Aesculap, kept in a dust-free area protected from chemical fumes and extreme air or temperature fluctuations.

For further information on the appropriate storage devices recommended by Aesculap, please contact your local Aesculap sales representative or consult the Yasargil Aneurysm Clip Brochure.

Distributor in the US/Contact in Canada for product information and complaints:

Aesculap, Inc.
3773 Corporate Parkway
Center Valley, PA 18034 USA
1-800-227-2862

Yasargil is a registered trademark in the name of Aesculap AG.
Prolystica is a registered trademark of STERIS Corporation.
Phynox is a registered trademark in the name of Aperam.